

PRELIMINARY DATA SHEET

SKY65171-21: 1930 – 2170 MHz, 0.5 W Power Amplifier

Applications

- CDMA2000 cellular band
- PCS1900 band
- WCDMA, Bands I and II
- Femtocell transmitters

Features

- Wideband frequency operation: 1930 to 2170 MHz
- High gain: > 27 dB
- OP1dB: > +27 dBm
- ACPR ≤ -48 dBc for P_{OUT} ≥ +18 dBm
- ACLR ≤ -45 dBc for P_{OUT} ≥ +18 dBm
- Single DC supply: 5 V
- Internal RF match and bias circuits
- PA on/off control voltage
- Small footprint, MCM (20-pin, 6 x 6 mm) SMT package (MSL3, 260 °C per JEDEC J-STD-020)



Skyworks Pb-free products are compliant with all applicable legislation. For additional information, refer to *Skyworks Definition of Lead (Pb)-Free*, document number SQ04-0073.

Description

Skyworks SKY65171-21 is a fully-matched, 0.5 W Power Amplifier (PA) with high efficiency, designed for use in the 1930 to 2170 MHz band.

The device is fabricated using Skyworks high reliability Indium Gallium Phosphide (InGaP) Heterojunction Bipolar Transistor (HBT) technology. This process allows for single supply operation while maintaining high efficiency and good linearity.

The SKY65171-21 contains all of the active bias and RF matching circuits, which make it easy to integrate into 50 Ω RF systems. The internal input and output match are optimized for gain, 1 dB Compression Point (P1dB), Adjacent Channel Power Ratio (ACPR), Adjacent Channel Leakage Ratio (ACLR), and efficiency when integrated in a 50 Ω system.

The primary bias to the SKY65171-21 can be supplied directly from a single 5 VDC supply. The PA is designed to operate with lower current by reducing the bias voltage.

The device is internally matched and mounted in a 20-pin, 6 x 6 mm Multi-Chip Module (MCM) Surface-Mounted Technology (SMT) package, which allows for a highly manufacturable low cost solution. The device package and pinout for the 20-pin MCM are shown in Figure 1. A block diagram of the SKY65171-21 is shown in Figure 2.

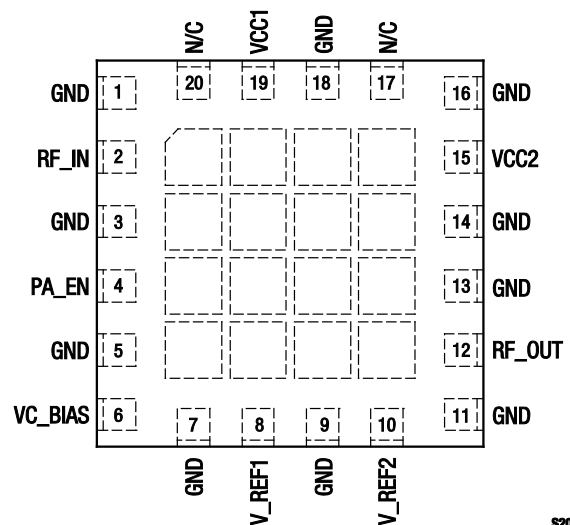

S2040a

Figure 1. SKY65171-21 Pinout – 20-Pin MCM (Top View)

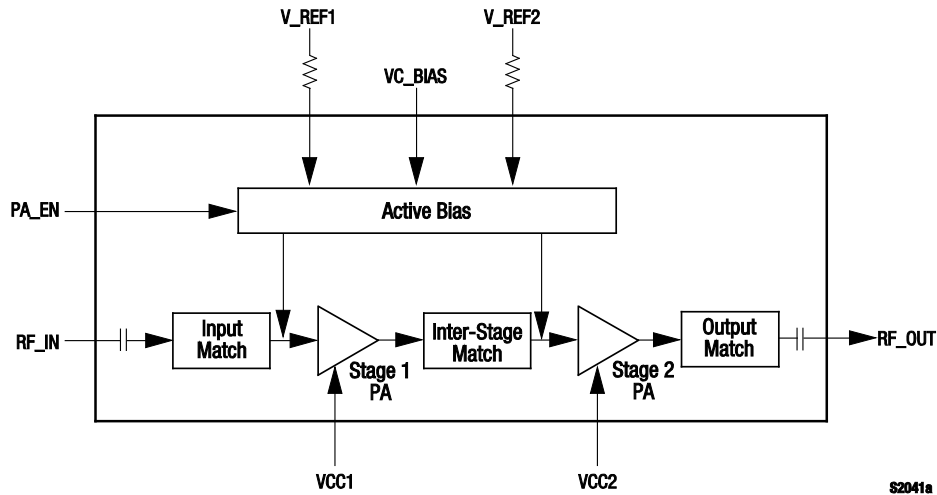

Figure 2. SKY65171-21 Block Diagram

Technical Description

The SKY65171-21 PA contains all of the needed RF matching and DC biasing circuits. The device is a two-stage, HBT InGaP device optimized for high linearity and power efficiency. These features make the device suitable for wideband digital applications, where PA linearity and power consumption are of critical importance (e.g., femtocell and infrastructure applications).

The device has been characterized with standard CDMA2000 and WCDMA modulated signals. Under these stringent test conditions, the device exhibits excellent spectral purity and power efficiency.

Electrical and Mechanical Specifications

Signal pin assignments and functional pin descriptions are described in Table 1. The absolute maximum ratings of the SKY65171-21 are provided in Table 2. Electrical specifications are provided in Table 3.

Typical performance characteristics of the SKY65171-21 are illustrated in Figures 3 through 8.

Table 1. SKY65171-21 Signal Descriptions

Pin #	Name	Description	Pin #	Name	Description
1	GND	Ground	11	GND	Ground
2	RF_IN	RF input	12	RF_OUT	RF output
3	GND	Ground	13	GND	Ground
4	PA_EN	PA enable	14	GND	Ground
5	GND	Ground	15	VCC2	Stage 2 collector voltage, 5 V
6	VC_BIAS	Bias voltage, 5 V	16	GND	Ground
7	GND	Ground	17	N/C	No connection
8	V_REF1	Bias reference 1 voltage, 5 V	18	GND	Ground
9	GND	Ground	19	VCC1	Stage 1 collector voltage, 5 V
10	V_REF2	Bias reference 2 voltage, 5 V	20	N/C	No connection

Table 2. SKY65171-21 Absolute Maximum Ratings (Note 1)

Parameter	Symbol	Minimum	Maximum	Units
RF output power	P _{OUT}		+30	dBm
Supply voltage	VCC1, VCC2, V_REF1, V_REF2, VC_BIAS		5.5	V
PA enable voltage	PA_EN	3	5	V
Total supply current	I _{CC}		700	mA
Storage temperature	T _{ST}	-55	+125	°C
Junction temperature	T _J		+150	°C
Thermal resistance	Θ _{JC}		30	°C/W

Note 1: Exposure to maximum rating conditions for extended periods may reduce device reliability. There is no damage to device with only one parameter set at the limit and all other parameters set at or below their nominal value. Exceeding any of the limits listed here may result in permanent damage to the device.

CAUTION: Although this device is designed to be as robust as possible, Electrostatic Discharge (ESD) can damage this device. This device must be protected at all times from ESD. Static charges may easily produce potentials of several kilovolts on the human body or equipment, which can discharge without detection. Industry-standard ESD precautions should be used at all times.

Table 3. SKY65171-21 Recommended Operating Conditions

Parameter	Symbol	Minimum	Typical	Maximum	Units
Frequency range	f	1930		2170	MHz
Supply voltage (Note 1)	VCC1, VCC2	4.75	5.00	5.25	V
Bias voltage (Note 1)	VC_BIAS	4.75	5.00	5.25	V
	V_REF1, V_REF2		2.60	2.75	V
PA enable voltage (Note 1)	PA_EN	3		5	V
Reference current 1	I _{REF1}		5		mA
Reference current 2	I _{REF2}		12		mA
PA enable current	I _{PA_EN}		<1		mA
Case operating temperature	T _C	-40	+25	+85	°C

Note 1: Voltage levels measured at the pins of the package. The Evaluation Board supply voltage levels may be different. Refer to the Evaluation Board schematic diagram in this Data Sheet.

Table 4. SKY65171-21 Electrical Specifications (Note 1)**(VCC1 = VCC2 = V_REF1 = V_REF2 = VC_BIAS = 5 V, PA_EN = +5 V, T_c = +25 °C, f = 1960 MHz, Unless Otherwise Noted)**

Parameter	Symbol	Test Condition	Min	Typical	Max	Units
Output power @ 1 dB compression	OP1dB	CW	+27	+28		dBm
Small signal gain	IS21I	CW, P _{IN} = -15 dBm		30		dB
Adjacent Channel Power Ratio	ACPR1	@750 kHz, P _{OUT} = +18 dBm		-51	-48	dBc
	ACPR2	@1.98 MHz, P _{OUT} = +18 dBm		-66	-63	dBc
Adjacent Channel Leakage Ratio	ACLR	P _{OUT} = +18 dBm, with WCDMA test model 1, 64 DPCH		-45		dBc
3 rd Order Output Intercept Point	OIP3	P _{TONE} = +15 dBm, frequency spacing = 1 MHz		+36		dBm
Quiescent Current	I _Q	No RF input		150		mA
Operating current	I _{CC}	P _{OUT} = +18 dBm		180		mA
Noise Figure	NF			6.5		dB
Input return loss	IS11I	P _{IN} = -15 dBm	10	14		dB
Output return loss	IS22I	P _{IN} = -15 dBm	9	12		dB
Voltage Standing Wave Ratio for stable operation	VSWR	CW			8:1	-

Note 1: Performance is guaranteed only under the conditions listed in this Table.

Typical Performance Characteristics

(VCC1 = VCC2 = V_REF1 = V_REF2 = VC_BIAS = 5 V, PA_EN = +5 V, Tc = +25 °C, f = 1960 MHz, Unless Otherwise Noted)

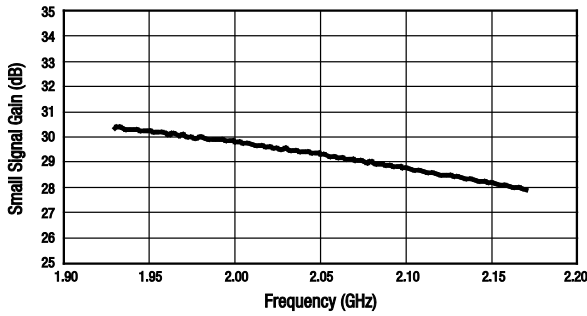

Figure 3. Small Signal Gain vs Frequency

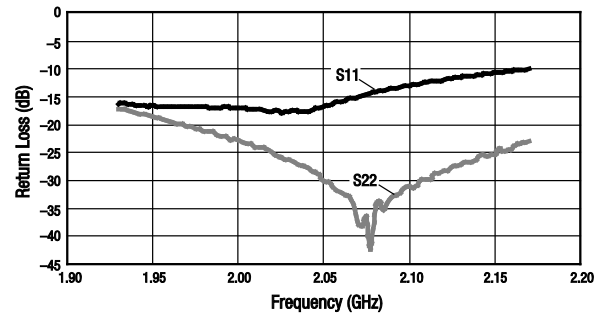

Figure 4. Return Loss vs Frequency

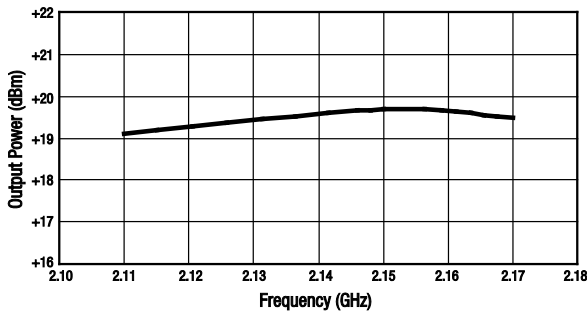

Figure 5. ACLR Limited Output Power vs Frequency (WCDMA Band I Test Model 1, 64 DPCH, ACLR = -45 dBc)

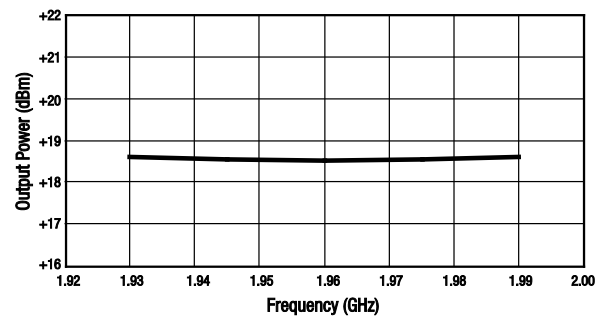

Figure 6. ACLR Limited Output Power vs Frequency (WCDMA Band II Test Model 1, 64 DPCH, ACLR = -45 dBc)

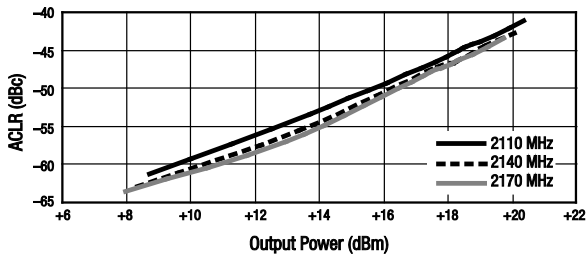

Figure 7. ACLR vs. Output Power (WCDMA Band I Test Model 1, 64 DPCH)

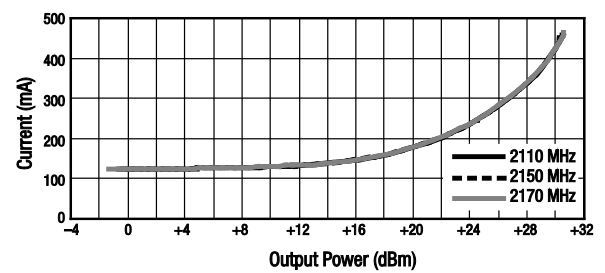

Figure 8. Current vs Output Power

Evaluation Board Description

The SKY65171-21 Evaluation Board is used to test the performance of the SKY65171-21 High Power PA. A schematic diagram of the SKY65171-21 Evaluation Board is shown in Figure 9. An assembly drawing for the Evaluation Board is shown in Figure 10 and the layer detail is provided in Figure 11. The layer detail physical characteristics are noted in Figure 12.

Package Dimensions

The PCB layout footprint for the SKY65171-21 is provided in Figure 13. Package dimensions for the 20-pin MCM are shown in Figure 14, and tape and reel dimensions are provided in Figure 15.

Package and Handling Information

Since the device package is sensitive to moisture absorption, it is baked and vacuum packed before shipping. Instructions on the shipping container label regarding exposure to moisture after the container seal is broken must be followed. Otherwise, problems related to moisture absorption may occur when the part is subjected to high temperature during solder assembly.

The SKY65171-21 is rated to Moisture Sensitivity Level 3 (MSL3) at 260 °C. It can be used for lead or lead-free soldering. For additional information, refer to Skyworks Application Note, *PCB Design and SMT Assembly/Rework Guidelines for MCM-L Packages*, document number 101752.

Care must be taken when attaching this product, whether it is done manually or in a production solder reflow environment. Production quantities of this product are shipped in a standard tape and reel format.

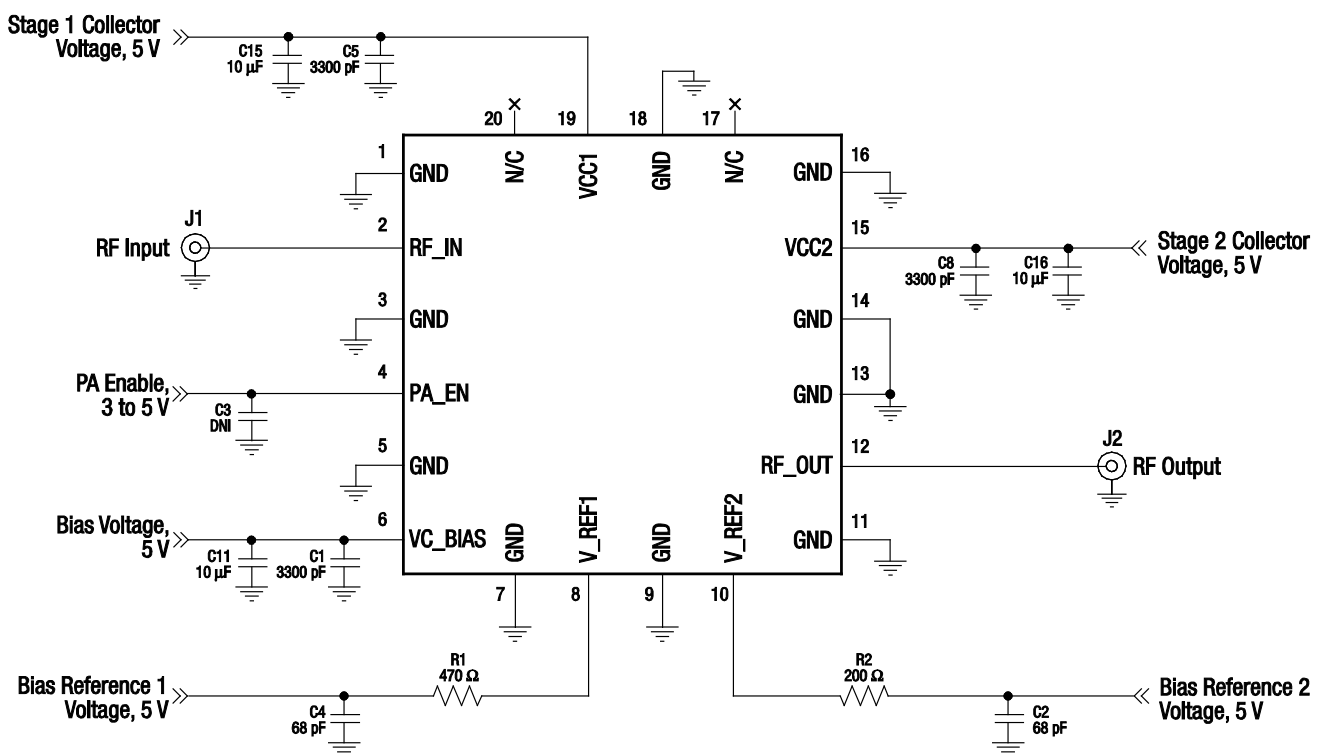

S2044b

Figure 9. SKY65171-21 Evaluation Board Schematic

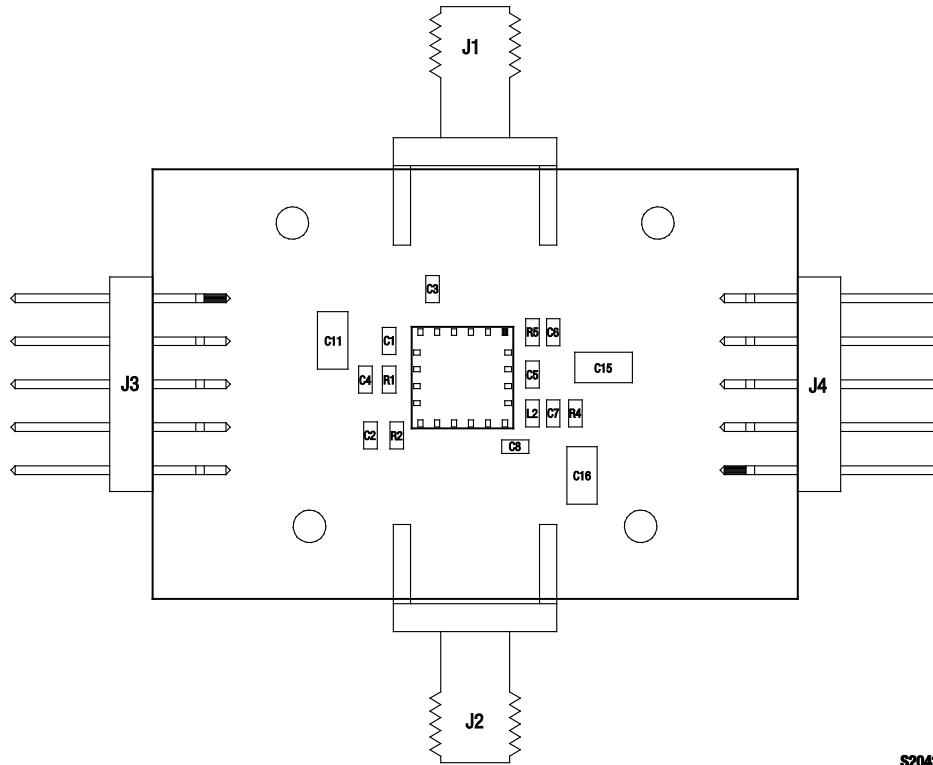

S2042

Figure 10. SKY65171-21 Evaluation Board Assembly Drawing

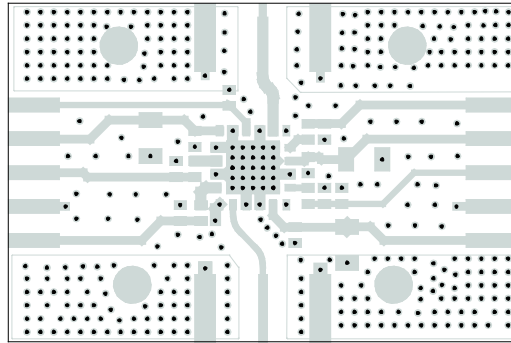

Layer 1: Top – Metal

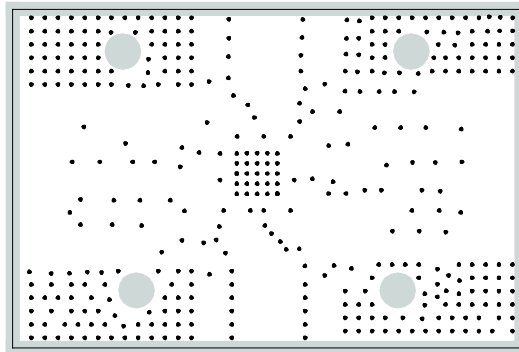

Layer 2: Ground

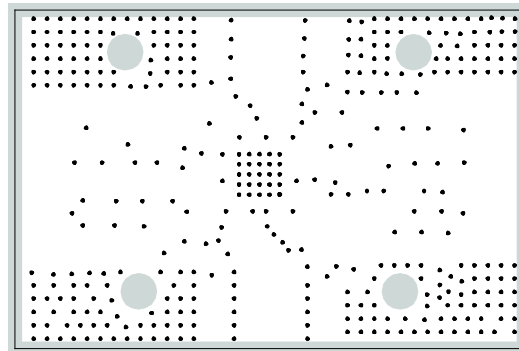



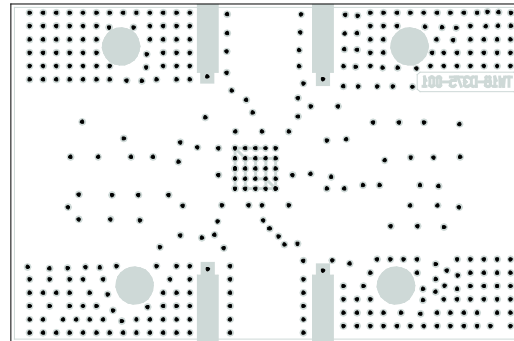

Layer 3: Ground Plane

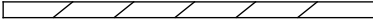

Layer 4: Solid Ground Plane

S2047

Figure 11. SKY65171-21 Evaluation Board Layer Detail

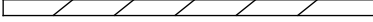
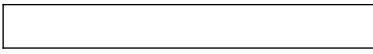
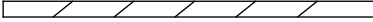
Cross Section	Name	Thickness (mm)	Material	ϵ_r
	Pri	0.036	Cu, 1 oz.	-
	Die1	0.250	Rogers 4350	3.38
	L2	0.036	Cu, 1 oz.	-
	Die2	0.175	FR4-4	4.35
	L3	0.036	Cu, 1 oz.	-
	Die3	0.250	FR4-12	4.35
	Sec	0.036	Cu, 1 oz.	-

S2048

Figure 12. Layer Detail Physical Characteristics

*** TBD ***

Figure 13. SKY65171-21 PCB Layout Footprint

PRELIMINARY DATA SHEET • SKY65171-21 0.5 W POWER AMPLIFIER

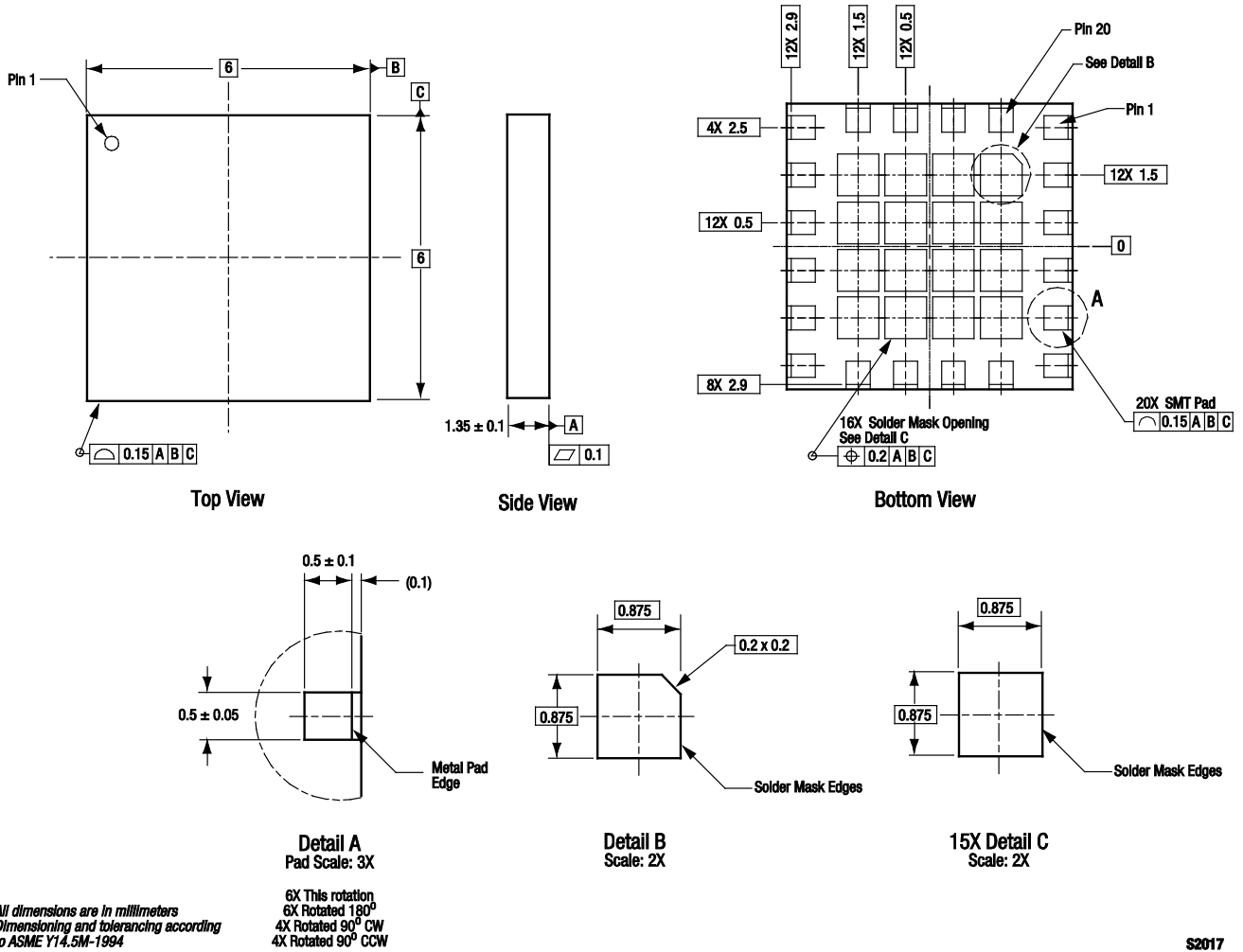

S2017

Figure 14. SKY65171-21 20-Pin MCM Package Dimensions

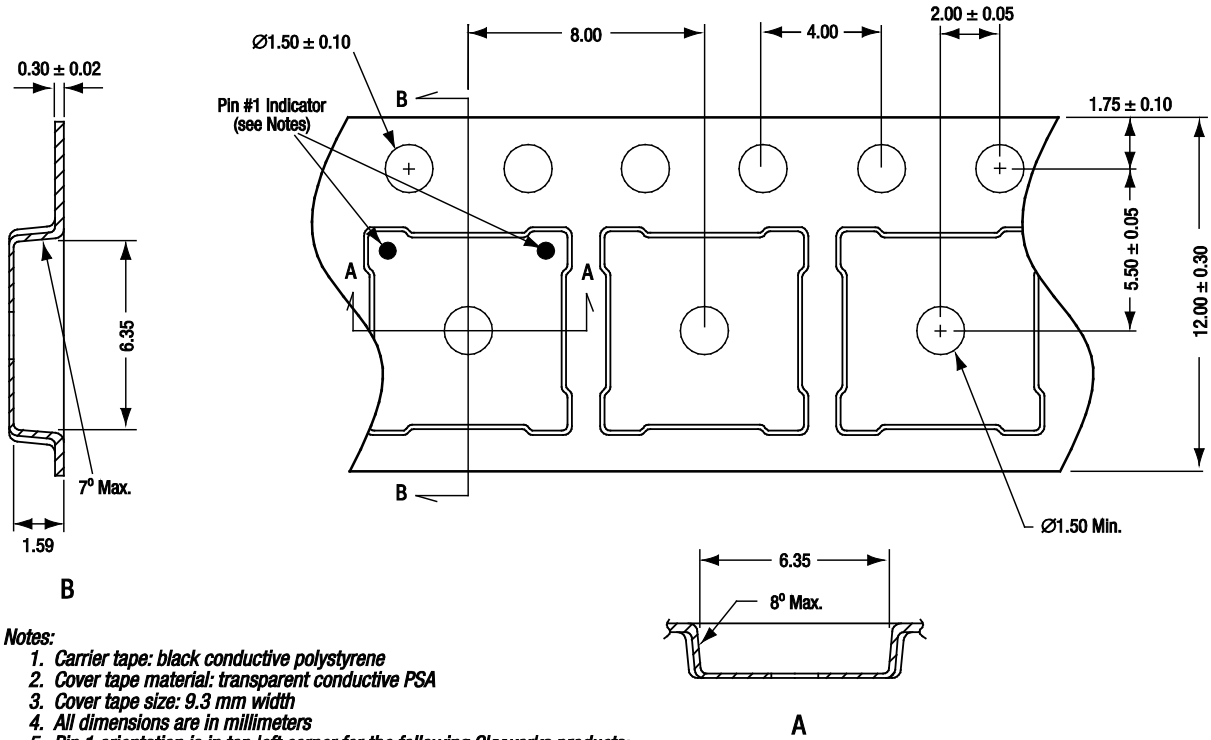

- Notes:**
1. Carrier tape: black conductive polystyrene
 2. Cover tape material: transparent conductive PSA
 3. Cover tape size: 9.3 mm width
 4. All dimensions are in millimeters
 5. Pin 1 orientation is in top left corner for the following Skyworks products:

SKY73022-21, -31
SKY73023-21, -31

For all other 6 x 6 mm MCM/RFLGA products, pin 1 orientation is in top right corner.

S1183

Figure 15. SKY65171-21 20-Pin MCM Tape and Reel Dimensions

Ordering Information

Model Name	Manufacturing Part Number	Evaluation Board Part Number
SKY65171-21 0.5 W, 1930-2170 MHz Power Amplifier	SKY65171-21	TW18-D370

Copyright © 2010, 2011 Skyworks Solutions, Inc. All Rights Reserved.

Information in this document is provided in connection with Skyworks Solutions, Inc. ("Skyworks") products or services. These materials, including the information contained herein, are provided by Skyworks as a service to its customers and may be used for informational purposes only by the customer. Skyworks assumes no responsibility for errors or omissions in these materials or the information contained herein. Skyworks may change its documentation, products, services, specifications or product descriptions at any time, without notice. Skyworks makes no commitment to update the materials or information and shall have no responsibility whatsoever for conflicts, incompatibilities, or other difficulties arising from any future changes.

No license, whether express, implied, by estoppel or otherwise, is granted to any intellectual property rights by this document. Skyworks assumes no liability for any materials, products or information provided hereunder, including the sale, distribution, reproduction or use of Skyworks products, information or materials, except as may be provided in Skyworks Terms and Conditions of Sale.

THE MATERIALS, PRODUCTS AND INFORMATION ARE PROVIDED "AS IS" WITHOUT WARRANTY OF ANY KIND, WHETHER EXPRESS, IMPLIED, STATUTORY, OR OTHERWISE, INCLUDING FITNESS FOR A PARTICULAR PURPOSE OR USE, MERCHANTABILITY, PERFORMANCE, QUALITY OR NON-INFRINGEMENT OF ANY INTELLECTUAL PROPERTY RIGHT; ALL SUCH WARRANTIES ARE HEREBY EXPRESSLY DISCLAIMED. SKYWORKS DOES NOT WARRANT THE ACCURACY OR COMPLETENESS OF THE INFORMATION, TEXT, GRAPHICS OR OTHER ITEMS CONTAINED WITHIN THESE MATERIALS. SKYWORKS SHALL NOT BE LIABLE FOR ANY DAMAGES, INCLUDING BUT NOT LIMITED TO ANY SPECIAL, INDIRECT, INCIDENTAL, STATUTORY, OR CONSEQUENTIAL DAMAGES, INCLUDING WITHOUT LIMITATION, LOST REVENUES OR LOST PROFITS THAT MAY RESULT FROM THE USE OF THE MATERIALS OR INFORMATION, WHETHER OR NOT THE RECIPIENT OF MATERIALS HAS BEEN ADVISED OF THE POSSIBILITY OF SUCH DAMAGE.

Skyworks products are not intended for use in medical, lifesaving or life-sustaining applications, or other equipment in which the failure of the Skyworks products could lead to personal injury, death, physical or environmental damage. Skyworks customers using or selling Skyworks products for use in such applications do so at their own risk and agree to fully indemnify Skyworks for any damages resulting from such improper use or sale.

Customers are responsible for their products and applications using Skyworks products, which may deviate from published specifications as a result of design defects, errors, or operation of products outside of published parameters or design specifications. Customers should include design and operating safeguards to minimize these and other risks. Skyworks assumes no liability for applications assistance, customer product design, or damage to any equipment resulting from the use of Skyworks products outside of stated published specifications or parameters.

Skyworks, the Skyworks symbol, and "Breakthrough Simplicity" are trademarks or registered trademarks of Skyworks Solutions, Inc., in the United States and other countries. Third-party brands and names are for identification purposes only, and are the property of their respective owners. Additional information, including relevant terms and conditions, posted at www.skyworksinc.com, are incorporated by reference.